

down-led

ficha técnica

datasheet

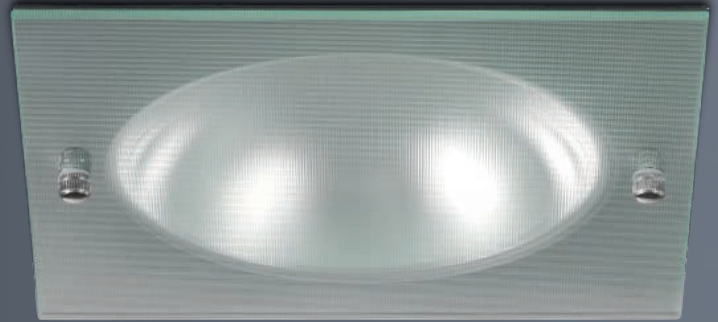

ref. 4790160

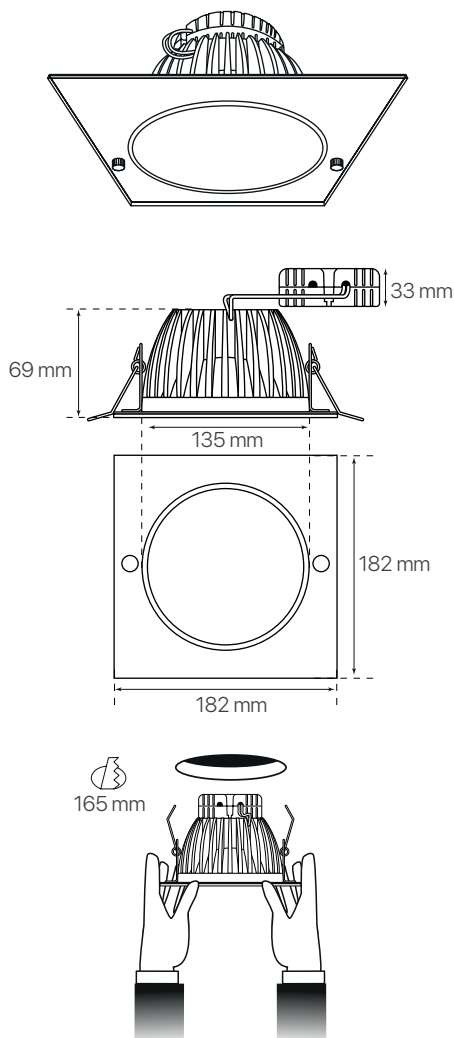

Nombre / Name	Down-led
Referencia / Reference	4790160
Materiales / Materials	Aluminio + cristal / Aluminum + glass
Difusor / Diffuser	Cristal / Crystal
Potencia / Power	15W
Temperatura de color / Color temperature	6400K
Flujo luminoso / Luminous flux	1500lm
Dimable / Dimmable	No
Ángulo de apertura / Beam angle	60°
Ángulo de inclinación / Inclination angle	-
IP	20
IK	-
F.P	-
UGR	-
IRC	-
Chip	EPISTAR
Driver	i-TEC series
Vida media (duración) / Average life	30.000 ~ 50.000h
Clase energética / Energy class	A
Aislamiento eléctrico / Electrical isolation	-
Colores / Colors	Niquel mate / Nickel matte
Medida exterior / Product size	182mm x 182mm x 69mm
Medidas de corte / Cutting measurements	Ø165mm
Tª (ambiente/trabajo) / Tª (environment/work)	-20°C ~ 40°C
Input	AC100 ~ 240V
Output	DC15 ~ 30V 600mA
Frecuencia / Frequency	50 / 60Hz
Peso / Weight	1,100Kg
Certificados / Certificates	CE & RoHS
Garantía / Warranty	2 años / 2 years